

Product family: Terminals - Insulated terminal lugs from sheet
Code: 00152, 00153, 00252, 00253, 00352, 00353
Description: TERMINAL LUGS FOR COPPER CONDUCTORS · PVC INSULATED FROM SHEET · BLADE PIN

Image:

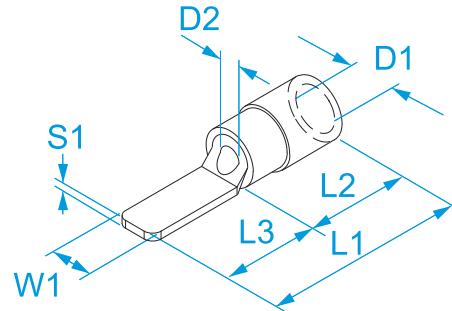







Technical Drawing:



Specifications:

TERMINAL MATERIAL: tinned copper
INSULATION MATERIAL: polyvinylchloride (PVC)
INSULATION SELF-EXTINGUISHING GRADE: UL 94 V0
RATED VOLTAGE: 300 V max
OPERATING TEMPERATURE: 75 °C max

Code	Color	Section (mm ²)	Section (AWG/MCM)	W1 (mm)	L1 (mm)	L2 (mm)	L3 (mm)	D1 (mm)	D2 (mm)	S1 (mm)	
00152		0.25 ÷ 1.5	(22 - 16)	2,8	18,5	9,5	9	4	1,95	0,8	100/1000
00153		0.25 ÷ 1.5	(22 - 16)	3	24	9,5	14,5	4	1,95	0,8	
00252		1.5 ÷ 2.5	(16 - 14)	2,8	18,5	9,5	9	4,5	2,45	0,8	100/1000
00253		1.5 ÷ 2.5	(16 - 14)	2,8	25,5	9,5	16	4,5	2,45	0,8	
00352		4 ÷ 6	(12 - 10)	2,8	24	14	10,4	6,6	3,5	1	50/500
00353		4 ÷ 6	(12 - 10)	4,5	32	14	18	6,6	3,5	1	