

Product family: Terminals - End-sleeves terminals
Item code: 91501, 91601, 91502, 91702, 91602, 91503, 91603, 91504, 91604, 91506, 91706
Description: END-SLEEVES FOR COPPER CONDUCTORS · INSULATED · SINGLE CABLE · IN A REEL

Image

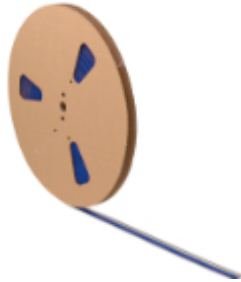

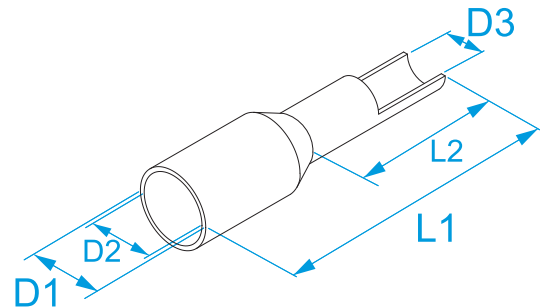









Technical drawing



Specifications

TERMINAL MATERIAL: tinned copper
INSULATION MATERIAL: polypropylene (PP) without flame retardant
OPERATING TEMPERATURE: 105°C max
ACCORDING TO STD.: DIN 46228-4 (tubular ferrules with plastic sleeve), UL486F (bare and covered ferrules)
REEL: Diametro Esterno: 45 cm
 Diametro Foro: 2,3 cm
 Spessore: 3 cm

Code	Color	Standard color 1	Standard color 2	Color DIN 46228/4	Section (mm ²)	Section (AWG/MCM)	L1 (mm)	L2 (mm)	D1 (mm)	D2 (mm)	D3 (mm)		
91501		Orange	√	-	-	0,5	(20)	14	8	3,1	2,6	1	10000/10000
91601*		White	-	√	√	0,5	(20)	14	8	3,1	2,6	1	
91502		White	√	-	-	0,75	(18)	14	8	3,3	2,8	1,2	10000/10000
91702		Blue	-	√	-	0,75	(18)	14	8	3,3	2,8	1,2	
91602*		Grey	-	-	√	0,75	(18)	14	8	3,3	2,8	1,2	7500/7500
91503		Yellow	√	-	-	1	(18)	14	8	3,5	3	1,4	
91603*		Red	-	√	√	1	(18)	14	8	3,5	3	1,4	7500/7500
91504		Red	√	-	-	1,5	(16)	14	8	4	3,5	1,7	
91604*		Black	-	√	√	1,5	(16)	14	8	4	3,5	1,7	5000/5000
91506*		Blue	√	-	√	2,5	(14)	14	8	4,7	4,2	2,2	
91706		Grey	-	√	-	2,5	(14)	14	8	4,7	4,2	2,2	



* file n° E 506333

HALOGEN FREE