

**Famiglia prodotto:** Terminali - Terminali a bussola  
**Codici articolo:** 91501, 91601, 91502, 91702, 91602, 91503, 91603, 91504, 91604, 91506, 91706  
**Descrizione:** TERMINALI A BUSSOLA PER CONDUTTORI IN RAME · PREISOLATI · CAVO SINGOLO · IN BOBINA

Immagine

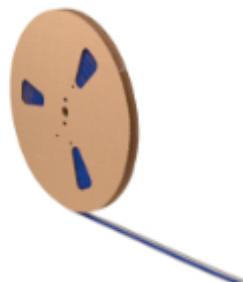

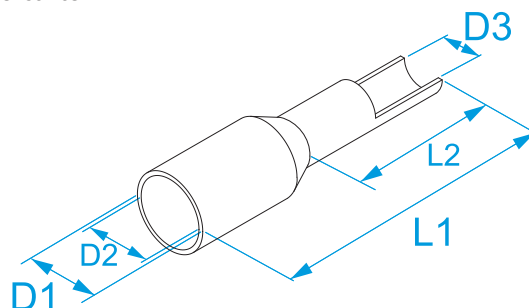









Disegno tecnico



### Specifiche

**MATERIALE TERMINALE:** rame stagnato  
**MATERIALE ISOLANTE:** polipropilene (PP) senza ritardante di fiamma  
**TEMPERATURA ESERCIZIO:** 105°C max  
**NORME DI RIF.:** DIN 46228-4 (terminali a bussola isolati), UL486F (terminali a bussola isolati e non isolati)  
**BOBINA:** Diametro Esterno: 45 cm  
 Diametro Foro: 2,3 cm  
 Spessore: 3 cm

Codice	Colore	Colore standard 1	Colore standard 2	Colore DIN 46228/4	Sezione (mm <sup>2</sup> )	Sezione (AWG/MCM)	L1 (mm)	L2 (mm)	D1 (mm)	D2 (mm)	D3 (mm)	
91501		Arancio	√	-	-	0,5 (20)	14	8	3,1	2,6	1	10000/10000
91601*		Bianco	-	√	√	0,5 (20)	14	8	3,1	2,6	1	
91502		Bianco	√	-	-	0,75 (18)	14	8	3,3	2,8	1,2	
91702		Blu	-	√	-	0,75 (18)	14	8	3,3	2,8	1,2	10000/10000
91602*		Grigio	-	-	√	0,75 (18)	14	8	3,3	2,8	1,2	
91503		Giallo	√	-	-	1 (18)	14	8	3,5	3	1,4	7500/7500
91603*		Rosso	-	√	√	1 (18)	14	8	3,5	3	1,4	
91504		Rosso	√	-	-	1,5 (16)	14	8	4	3,5	1,7	7500/7500
91604*		Nero	-	√	√	1,5 (16)	14	8	4	3,5	1,7	
91506*		Blu	√	-	√	2,5 (14)	14	8	4,7	4,2	2,2	5000/5000
91706		Grigio	-	√	-	2,5 (14)	14	8	4,7	4,2	2,2	



\* file n° E 506333

**HALOGEN FREE**